

Maßvorlage

Platzierung - Aluminiumpfosten seitliche Verankerung

Außenecke

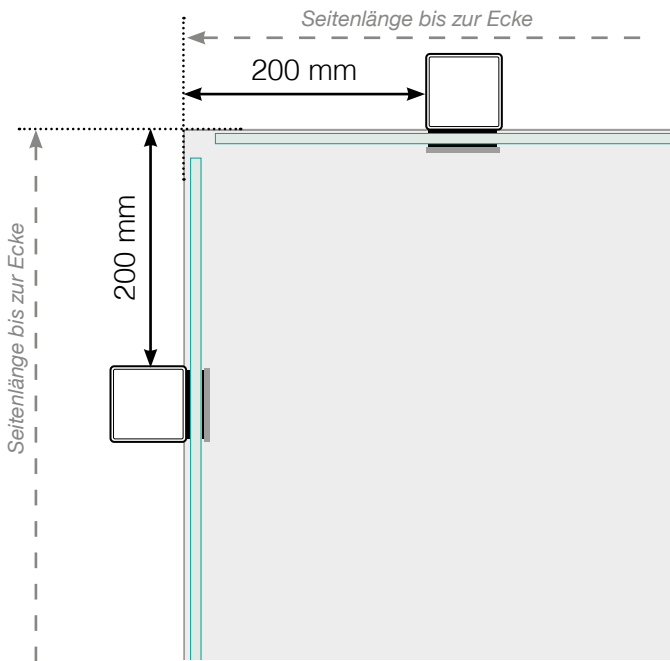

Außenecke > 90°

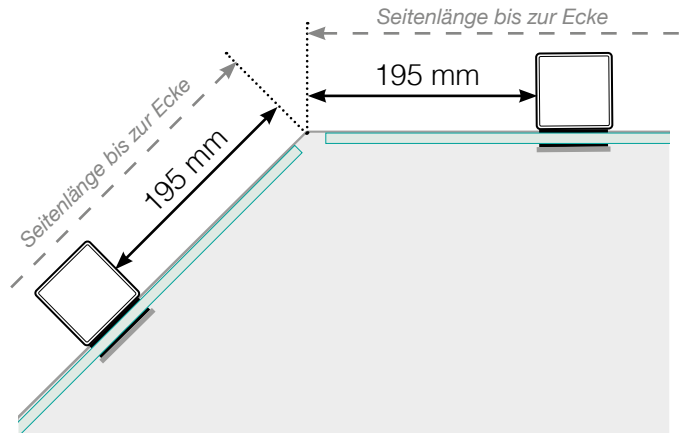

Innenecke

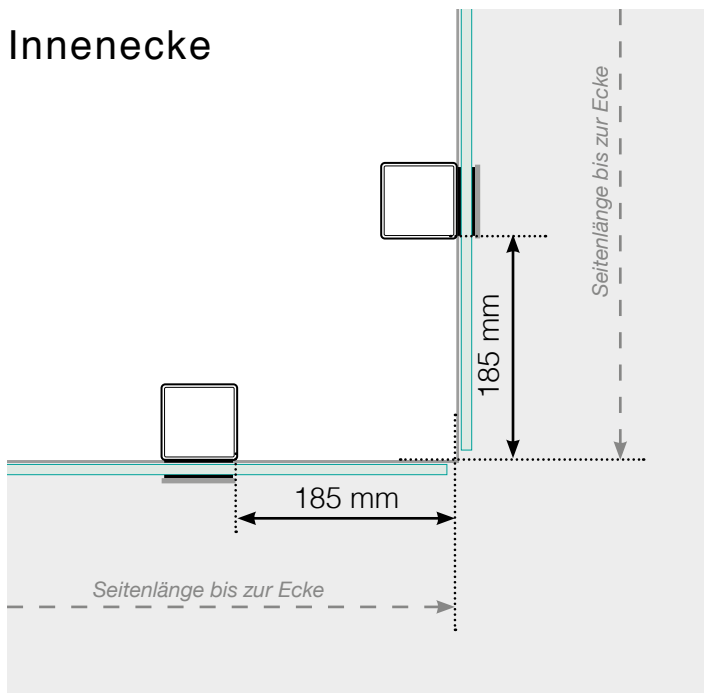

Innenecke > 90°

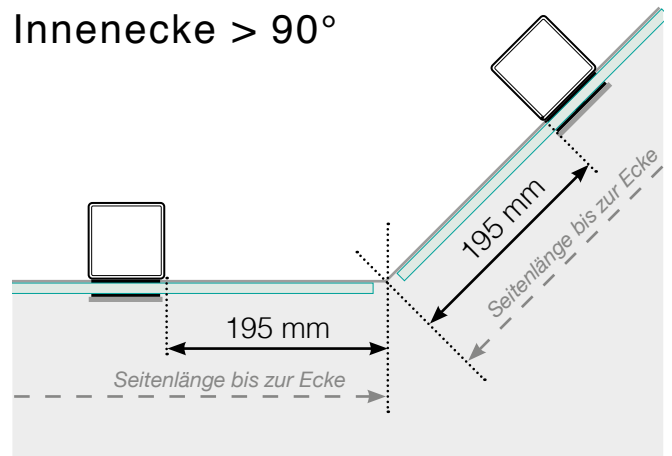

Endpfosten

Freies Ende

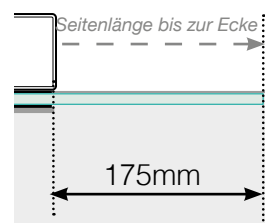

An einer Wand

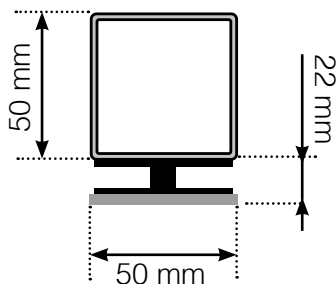
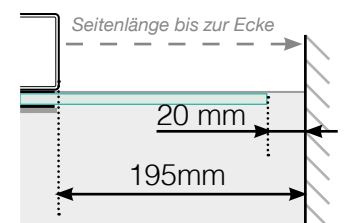

Abstand bei geraden Sektionen

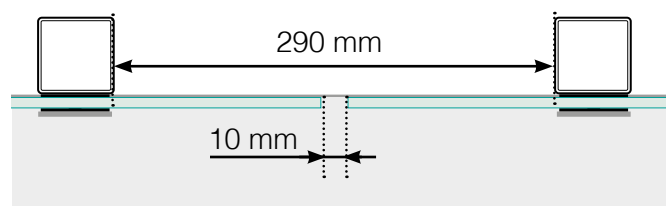

Achtung: Die Zeichnungen sind nicht maßstabgetreu

© Räckesbutiken Sweden AB - www.gelaenderladen.de

01.09.2019 v.1.0