

# Maßvorlage

Platzierung - Aluminiumpfosten mit Fuß - Glasmontage außenseite

## Außenecke

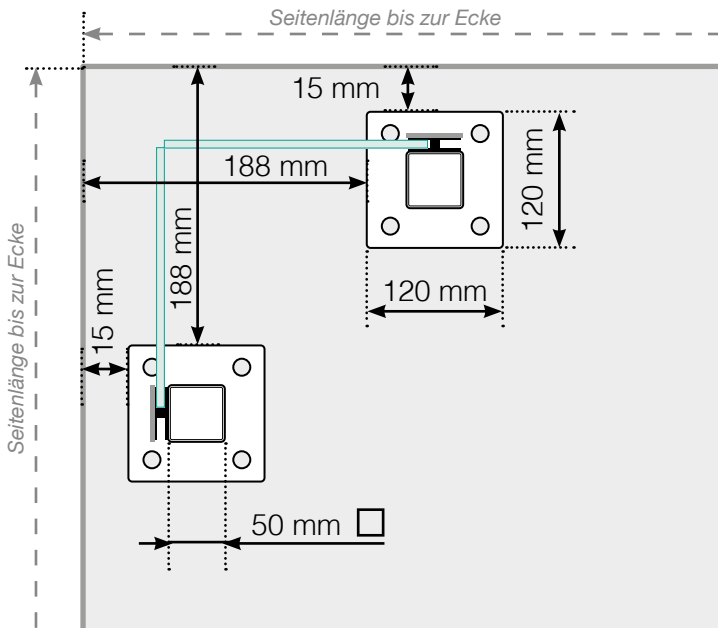

## Außenecke > 90°

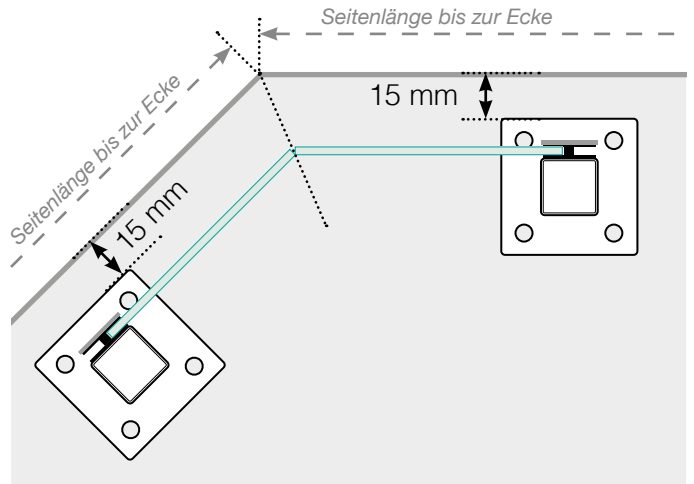

## Innenecke > 90°

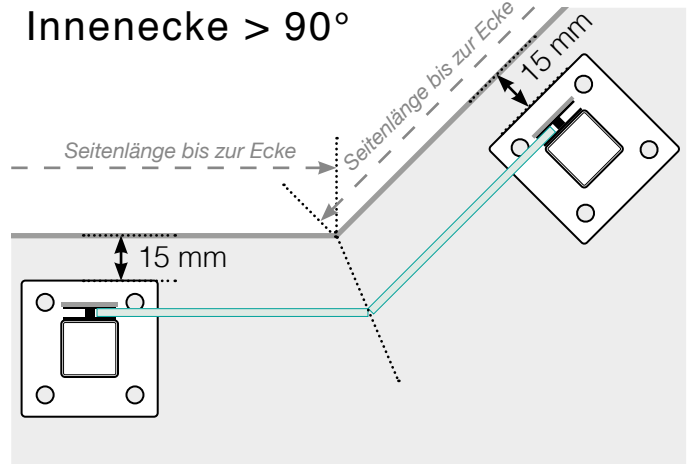

## Innenecke

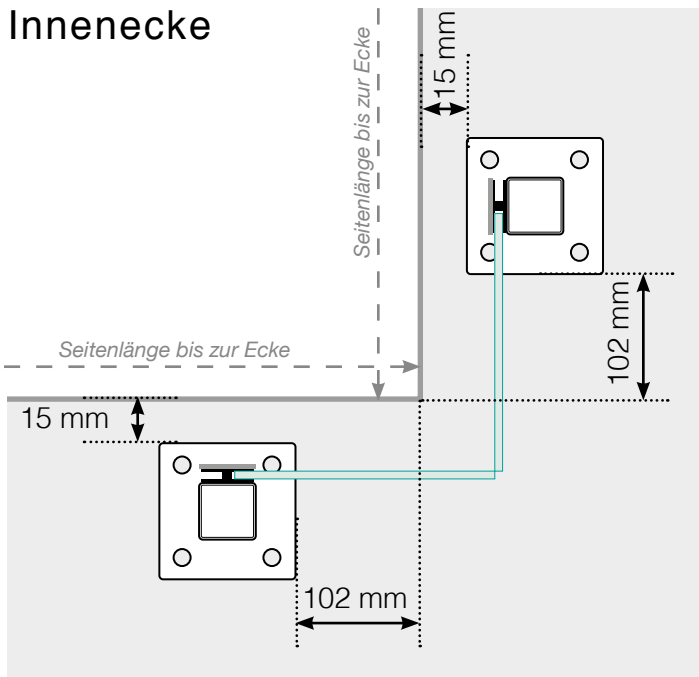

## Endpfosten

Freies Ende

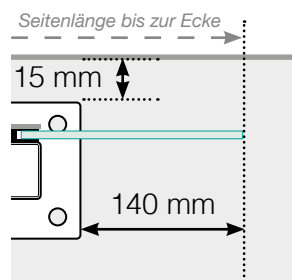

An einer Wand

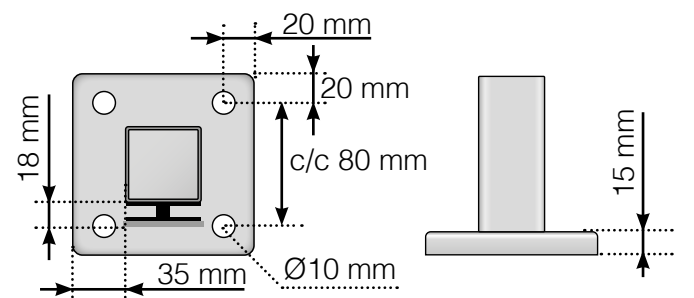
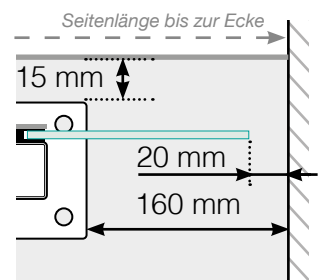

Achtung: Die Zeichnungen sind nicht maßstabgetreu

© Räckesbutiken Sweden AB - www.gelaenderladen.de

01.11.2018 v.1.0