

Maßvorlage

Platzierung - Aluminiumpfosten mit Fuß - Glasmontage Innenseite

Außenecke

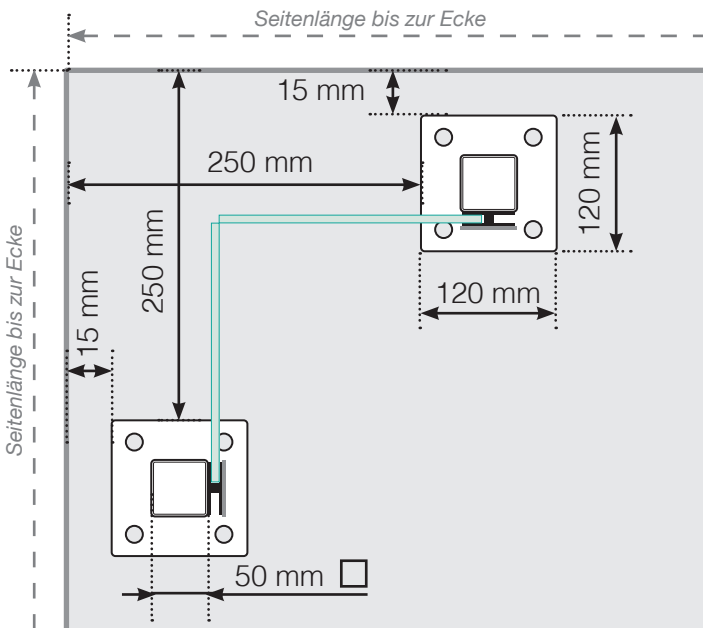

Außenecke > 90°

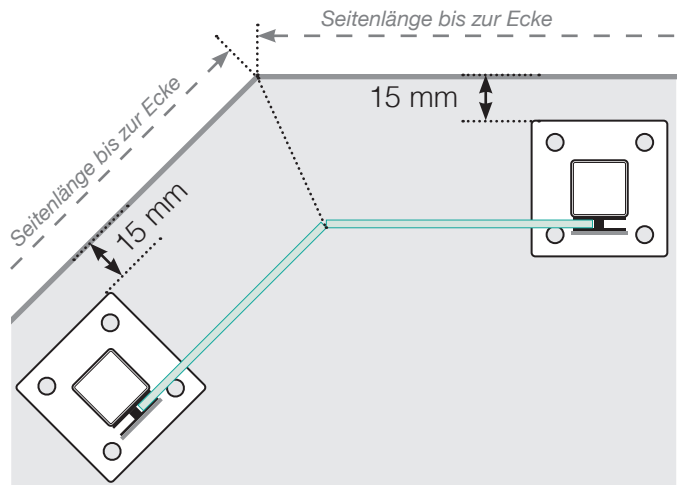

Innenecke > 90°

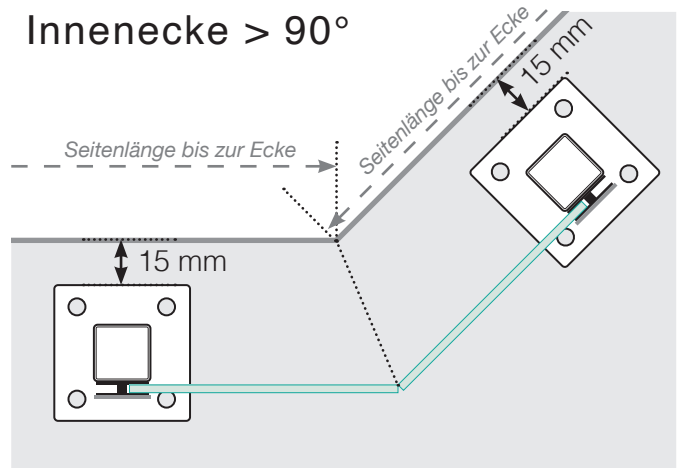

Innenecke

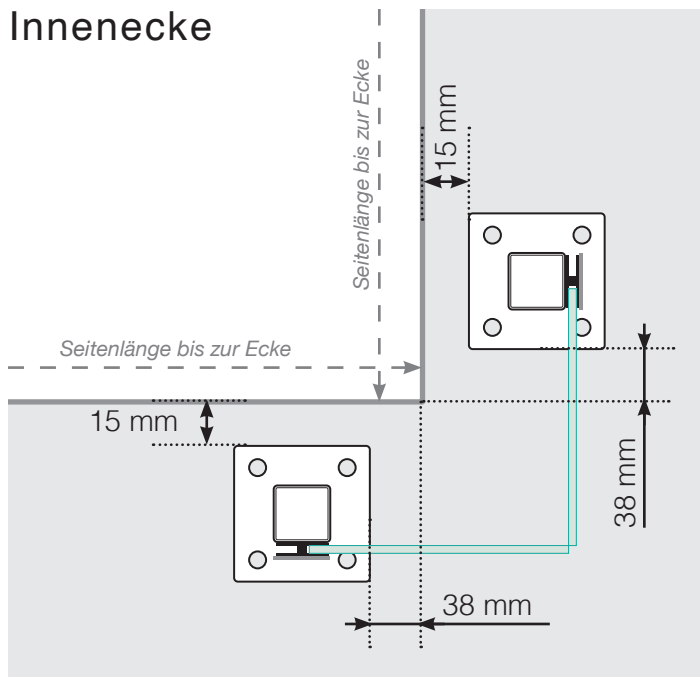

Endpfosten

Freies Ende

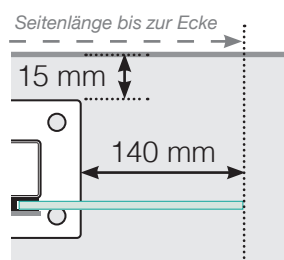

An einer Wand

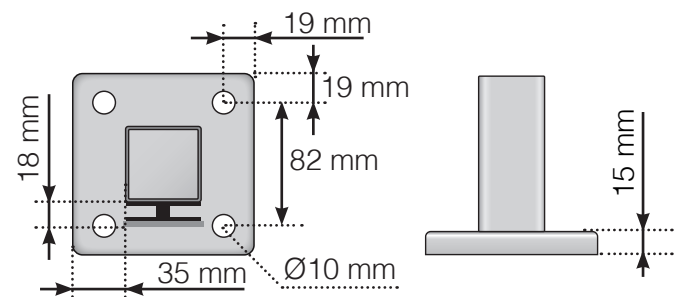
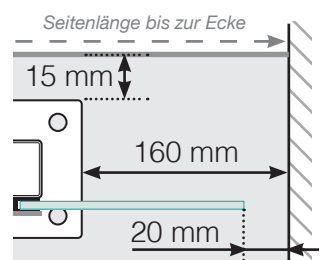

Achtung: Die Zeichnungen sind nicht maßstabgetreu

© Räckesbutiken Sweden AB - www.gelaenderladen.de

18.09.2020 v.1.0