

Maßvorlage

Platzierung - Edelstahlpfosten mit Fuß

Außenecke

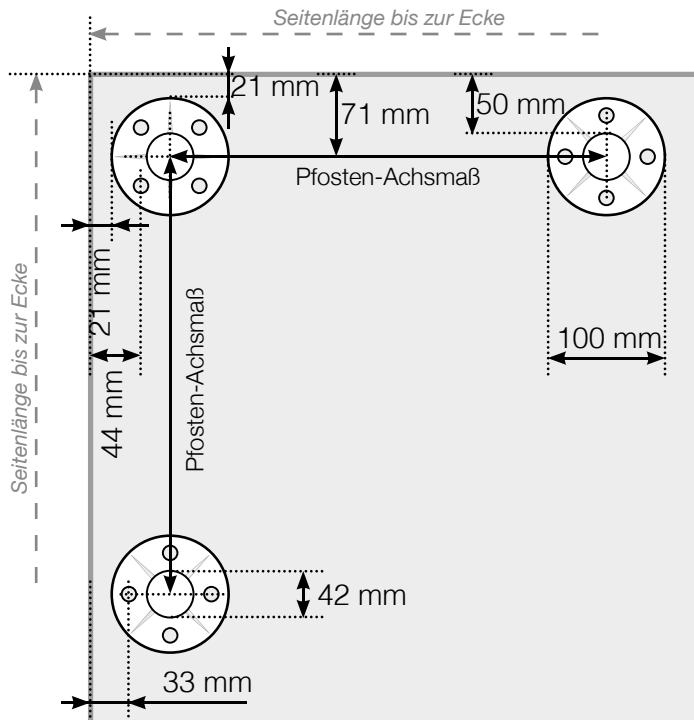

Außenecke > 90°

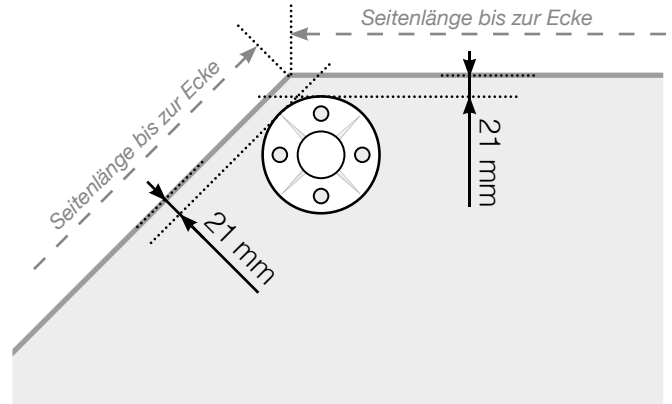

Innenecke > 90°

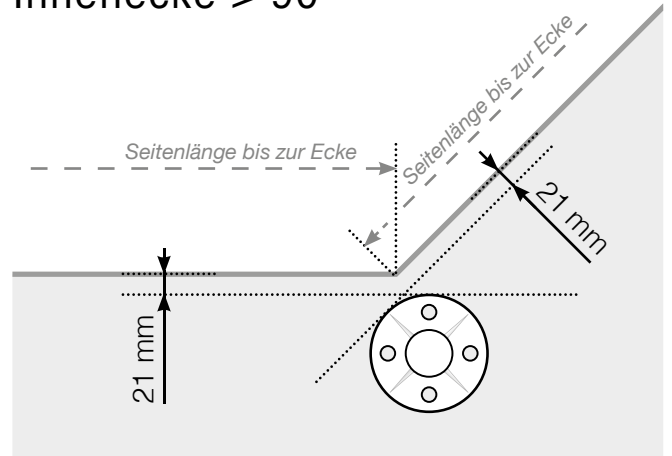

Innenecke

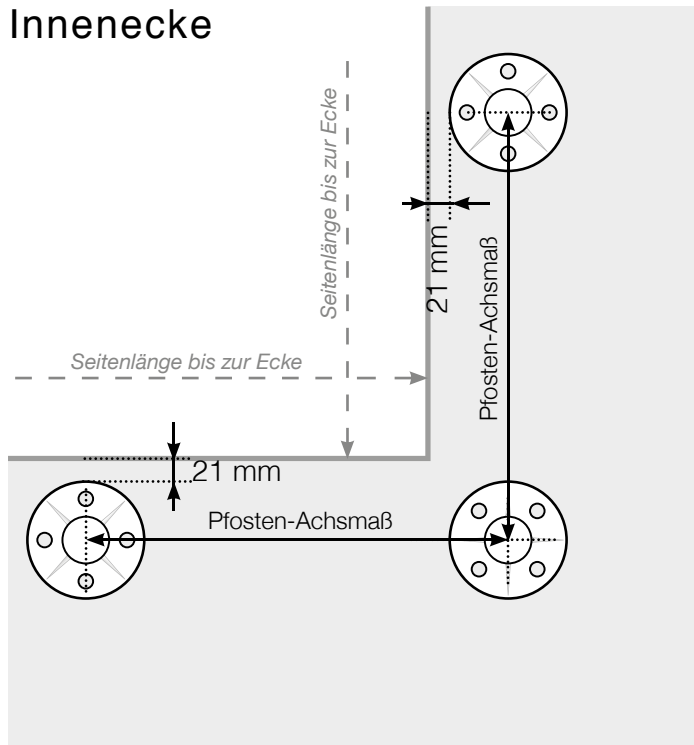

Endpfosten

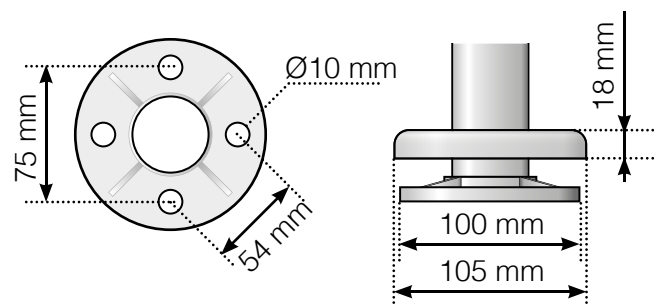
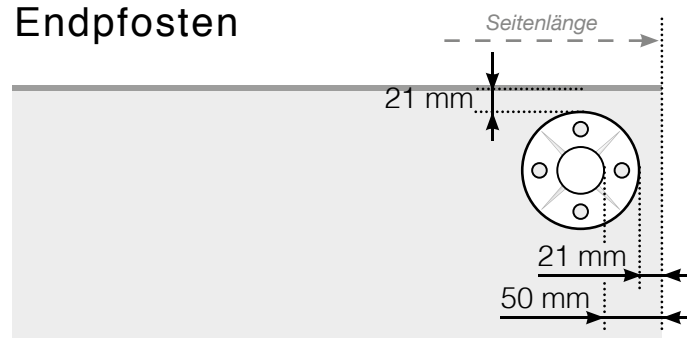

Achtung: Die Zeichnungen sind nicht maßstabgetreu

© Räckesbutiken Sweden AB - www.gelaenderladen.de

30.11.2017 v.1.0